



TUCK-AWAY NOAA SAME WEATHER RADIO

MODEL NO.: WRS101
USER'S MANUAL

SECTION 1 INTRODUCTION

Thank you for purchasing the WRS101 NOAA (National Oceanic Atmospheric Administration) - SAME (Specific Area Message Encoded) Weather Radio. This multifunctional radio with clock warns users of severe weather and environmental dangers.

The WRS101 comes with the following features and functions:

- Digital PLL tuning for seven NOAA channels
- SAME decoding and automatic alert activation
- Six county code settings for all SAME compatible counties

The WRS101 is also equipped with a clock with calendar, two daily alarms and backlight.

CONTROL BUTTONS AND CONNECTORS

A. NOAA BUTTON

Activates and turns off radio. Switches between NOAA-On, NOAA-Standby, NOAA-Mute and NOAA-OFF modes

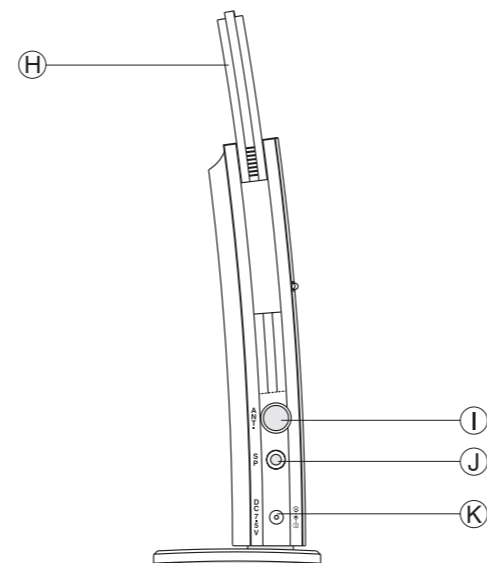
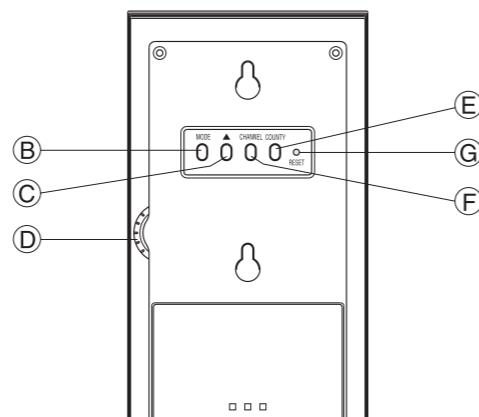
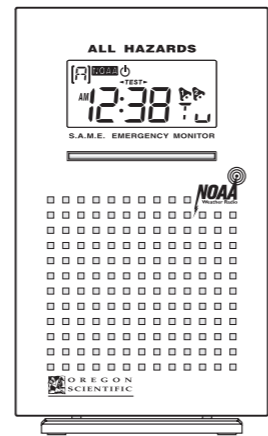
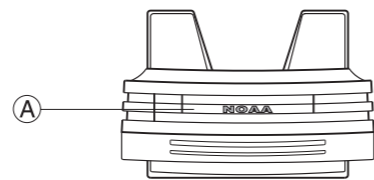

B. MODE BUTTON

Switches between clock, calendar and alarm modes

C. [▲] BUTTON

Changes the value of a setting

D. VOLUME KNOB

Rotates to adjust the audio broadcast volume

E. COUNTY BUTTON

Displays and switches between SAME county codes

F. CHANNEL BUTTON

Changes the NOAA channels

G. RESET BUTTON

Clears all settings and returns them to their original default values

H. RETRACTILE ANTENNA

Retractable antenna to enhance reception of NOAA signal

I. ANTENNA CONNECTION

Connection for an optional external antenna (not included)

J. SP (SPEAKER) CONNECTION

Connection for an optional external speaker (not included)

K. AC POWER ADAPTER CONNECTION

Connection for the AC power adapter (included)

POWER

The WRS101 uses the AC power adapter as its primary power source. Insert the AC power adapter connector into the WRS101 as shown, and the duplex plug into an electrical wall outlet.

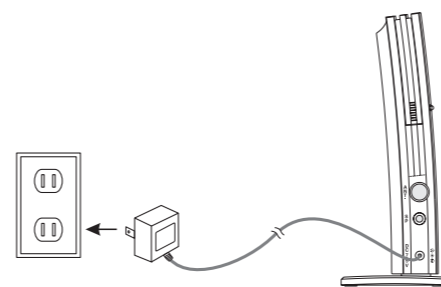

The WRS101 also uses batteries for emergency power back-up. As power outages are common in severe weather, it is recommended that back-up batteries be installed in the WRS101 at all times. Insert three AAA-sized (UM4) batteries (not included) into the battery compartment as shown below.

The WRS101 features a low battery warning icon. Change the batteries when the [] low battery icon is displayed

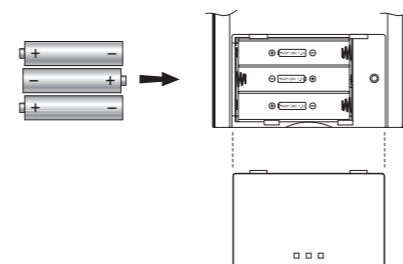

BEFORE YOU BEGIN

- Connect the AC power adapter and insert the batteries.
- In some areas, an optional external antenna may be needed to improve NOAA broadcast reception. Connect optional antenna if desired.
- An optional external speaker may be used to enhance broadcast quality. Connect optional speaker if desired.

THE BACKLIGHT

When powered by the AC power adapter, the backlight is on continuously. When powered by batteries, the WRS101 will automatically activate the backlight for 10 seconds when ALARM 1 or 2 is activated.

SECTION 2 THE CALENDAR CLOCK

DISPLAY MODES

There are four display modes: **CLOCK**, **CALENDAR**, **ALARM 1** and **ALARM 2**. To switch from one mode to another, press [MODE] to advance sequentially.

SETTING THE CLOCK & CALENDAR

1. Press [MODE] to select the clock or calendar display.
2. Press and hold [MODE] for two seconds.
3. Use [▲] to select 12-hour or 24-hour display format.
4. Press [MODE].
5. Use [▲] to enter the hours. When setting hours, be aware of the AM/PM designation.
6. Press [MODE].
7. Repeat steps 3 - 5 to advance sequentially and set the minutes, year, month, and date (choice of day-month or month-day format).
8. Press [MODE] to exit.

The WRS101 will save all changes and automatically return to normal display after 10 seconds.

SETTING THE ALARMS

1. Press [MODE] to select **ALARM 1** or **ALARM 2**.
 2. Press and hold [MODE] for two seconds.
 3. Use [▲] to enter the hours. When setting hours, be aware of the AM/PM designations.
 4. Press [MODE].
 5. Use [▲] to enter the minutes.
 6. Press [MODE] to exit.
- The chosen alarm will be automatically activated.

HOW TO USE THE ALARMS

To activate or deactivate an alarm:

1. Press [MODE] to select **ALARM 1** or **ALARM 2**.
2. Press [▲]. The set alarm time will be displayed when the selected alarm is activated. Otherwise, blanks will be displayed.
3. In the normal time mode, a bell icon [] with an identifying alarm number of 1 or 2 will be displayed indicating activated status of that alarm.
4. When an alarm sounds, press any button to deactivate the alarm.

NOTE: Both alarms can be active at the same time.

SECTION 3 THE NOAA WARNING SYSTEM

USING THE EARLY ALERT WARNING SYSTEM

The WRS101 has four NOAA activity status levels: **NOAA-On**, **NOAA-Stand-by**, **NOAA-Mute** and **NOAA-Off**.

1. **NOAA-On:** The radio is on and audio messages will be heard continuously.
2. **NOAA-Stand-by:** The radio is in standby mode and will activate automatically when an alert message is received.
3. **NOAA-Mute:** The radio is in standby mode without audio capability. When an alert message is received, the LED on the front of the WRS101 will flash red. Audio messages will not be heard until the radio is switched to NOAA-On mode
4. **NOAA-Off:** The radio is off and will not respond to alert messages.

To select an activity level, press [NOAA]. With each press, the status level advances sequentially.

To hear an alert message when the radio is in NOAA-Mute mode, press [NOAA] until the status becomes NOAA-On, and then adjust the volume level, if necessary.

ALERTS AND MESSAGES

When a NOAA message is detected, an alert will sound (**except in Mute or Off modes**), the front panel LED will flash. The alert type (warning, watch or statement) will be displayed. An audio broadcast will immediately follow the alert (**except in Mute or Off modes**). Once the audio broadcast is complete, the WRS101 will emit a short burst of static indicating completion of broadcast. If the WRS101 was in NOAA-Standby mode at the time of the alert, it will automatically return to that mode after completion of broadcast.

SAME MESSAGE CODES USED BY THE NWR

When the NWR airs alert warnings, a digital code known as "Specific Area Message Encoded" (SAME) is included as part of the warning. This code includes information specific to an affected or endangered local geographical area. With SAME codes, the user can select the geographical area(s) of interest and program the WRS101 to receive only those specific alerts. **When the WRS101 is programmed with SAME codes, the user will be alerted to warnings only for those pre-selected geographical areas.** Alerts are initially shown on the WRS101 as a text display on the LCD screen; then an audio broadcast will follow. At completion of the audio broadcast, the WRS101 will emit a short burst of static to indicate end of message.

In NOAA-Stand-by mode, the WRS101 will automatically turn to audio on so that the warning broadcast can be heard. The WRS101 will then return to NOAA-Stand-by mode after the audio broadcast has been completed.

FINDING LOCAL NWR CODES AND CHANNELS

SAME codes are available from the NWR. To contact the NWR by phone, call toll-free: 888-697-7263 and follow the voice menu to NWR channels and SAME codes. The NWR can also be contacted via the internet at: www.nws.noaa.gov/nwr/indexnw.htm then click on the state for which information is desired.

ABOUT NOAA CHANNELS

The NWR radio channels work in the same way as channels of a regular radio. All of the NWR transmission stations operate on one of seven frequencies:

Channel	Corresponding Radio Frequency
A	162.400MHz
B	162.425MHz
C	162.450MHz
D	162.475MHz
E	162.500MHz
F	162.525MHz
G	162.550MHz

The WRS101 labels each frequency channel "A" to "G." Once a radio frequency for a region has been selected, the WRS101 will receive audio and code information on this frequency. The radio channel is located in the upper left hand corner of the LCD screen.

CHANGING NOAA RADIO CHANNELS

- In any of the time display modes, press [CHANNEL] and hold for two (2) seconds. The channel selection icon will begin to flash.
- While the channel selection icon is flashing, press [▲] to scroll through the channel selections.
- When the channel has been selected, press [MODE] to save selection and return to time display mode.

PROGRAMMING SAME COUNTY CODES

SAME county codes are required to receive weather and environmental alerts for a selected specific county, and need to be entered into the WRS101. Up to seven selected SAME codes can be entered.

The first step in programming SAME codes requires the user to select the option of receiving [ALL] warnings or selected county warnings. **Selecting [ALL] will result in the WRS101 broadcasting all alerts and warnings issued on a particular radio frequency which can encompass a large geographical area of many counties.** To receive warnings for a specific county, that county code must be programmed into the WRS101

***NOTE:** It is recommended that the user program the WRS101 with specific county codes of interest or need in order to receive alerts and warnings pertinent to only those counties. Selecting [ALL] of the county code will result in the WRS101 receiving all of the messages for an entire transmission region. These regions are quite large and encompass about 5,000 square miles.*

Example of the first ten county radio channels and SAME codes for Montana:

ST.	COUNTY	SAME #	NWR TRANSMITTER	FREQMHZ	CALL	WATTS	REMARKS
MT	Beaverhead	030001	Butte MT	162.550	WXL79	100	
MT	Big Horn	030003	Billings MT	162.550	WXL27	400	
MT	Blaine	030005	Havre MT	162.400	WXL53	300	
MT	Broadwater	030007	Helena MT	162.400	WXK66	300	
MT	Carbon	030009	Billings MT	162.550	WXL27	400	
MT	Carter	030011	—No NWR Coverage—				
MT	Cascade	030013	Great Falls MT	162.550	WXJ43	300	
MT	Chouteau	030015	Havre MT	162.400	WXL53	300	
MT	Chouteau	030015	Great Falls MT	162.550	WXJ43	300	
MT	Custer	030017	Miles City MT	162.400	WXL54	300	

In addition, many counties have been further subdivided into as many as 9 smaller sub-sections. The numbers of one (1) to nine (9) in the far left column of a SAME code identifies specific sub-sections of a county. If the county has not been subdivided, the first digit of the county code will be zero (0).

ABOUT COUNTY CODES

A county code has six digits in the format of P-SS-CCC.

SS represents the Federal Information Processing System (FIPS) number assigned to each state or open waters in the country.

CCC represents the FIPS number assigned to each county. "000" means all areas under the state or open waters defined by SS.

P represents the smaller regions defined by CCC. "0" means all areas within the country. To specify a certain area in the county, the following coding system is used:

Code	Area
1	Northwest
2	North
3	Northeast
4	West
5	Central
6	East
7	Southwest
8	South
9	Southeast

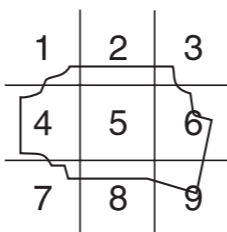

For example:

3	04	003	
			Code for Cochise County
			Code for Arizona
			Code for northeast sub-section of Cochise County

County code for Cochise County, Arizona

HOW TO SET THE COUNTIES

To enter the selected county code:

- Press [COUNTY] to enter the county-code display from Clock-Display mode.
- Press [COUNTY] again to by-pass county-code field zero (0) and advance to county-code field one (1).
- To enter the county code in this field, press and hold [COUNTY] for 2-seconds. The extreme left county-code digit will flash.
- To enter the first county-code digit, press [▲].
***REMEMBER:** This part of the code subdivides a county into small localized sections. If the county's code has not been sub divided into smaller sections, select zero (0) in the far left column.*
- To enter the remaining five (5) digits by following the same process. Press [COUNTY] followed by [▲].
- When finished, press [COUNTY] to advance to the next county-code field or wait 9-seconds to return to Clock-Display mode.

To enable or disable an individual county code:

- Locate the county number using [COUNTY]. To select [ALL] counties, choose COUNTY 0.
- Press [▲]. When a county is disabled, blanks will be displayed. To enable it again, simply press [▲] again.

Note that the unit will only response to enabled county codes.

SECTION 4 ADDITIONAL INFORMATION

THE RESET BUTTON

Press [RESET] to clear all settings and to cause them to return to their original default values. Use a blunt stylus to hold the button down.

SPECIFICATIONS

Radio Functions

Channels : Digital PLL tuning for Seven (7) NOAA channels
SAME code setting options : Six (6) independent settings or ALL counties

Time Functions

Clock : 12 or 24 hour format
Calendar : Day-of-the-week display
User-select month/day/year or day/month/year Format
Daily alarms : Two (2) one-minute duration alarms
Snooze : Eight (8) minutes alarm delay
Accuracy : +/- 0.5 seconds / day

General Specifications

Battery Type : Three AAA-size (or UM-4) size 1.5V alkaline batteries
LCD Dimensions : 1.93" (L) X 0.87" (W)
49 (L) X 22 (W) mm
Unit Dimensions : 5.3" (L) X 3.27" (W) X 0.91" (D)
134.5 (L) X 83 (W) X 23 (D) mm
Unit Weight : 3.87 oz / 110g (without batteries)
Operating Temperature : 23°F to 122°F / -5°C to 50°C

CUSTOMER ASSISTANCE

Oregon Scientific has made every effort to design and manufacture the WRS101 to provide you with many years of service. Should you have questions or require additional information, please contact our Customer Service Department at 800-853-8883 or via email at: helpme@oscientific.com. We also invite you to explore the international world of Oregon Scientific and our diverse line of practical and useful products designed to enhance your lifestyle and protect your family. Please visit our website at: www.oregonscientific.com.

WARRANTY

This product is warranted to be free of defects in manufacturing for 90 days after purchase. Defective product returns should be directed to the place of retail purchase. This warranty does not cover a product subjected to tampering, abuse, misuse or accidental damage.

CAUTION

- The content of this manual is subject to change without notice.
- Due to printing limitations, the line drawing displays shown in this manual may differ from the actual product displays.
- The manufacturer and its suppliers hold no responsibility to you or any other person for any damage expenses, lost profits, or any other claims arising by using this product.
- The contents of this manual may not be reproduced without the permission of the manufacturer.

NOTE ON COMPLIANCE

This device complies with Part 15 of the FCC Rules. Operation is subject to the following two conditions: (1) this device may not cause harmful interference, and (2) this device must accept any interference received, including interference that may cause undesired operation.

WARNING: Changes or modifications to this unit not expressly approved by the party responsible for compliance could void the user's authority to operate the equipment.

NOTE: This equipment has been tested and found to comply with the limits for a Class B digital device, pursuant to Part 15 of the FCC Rules. These limits are designed to provide reasonable protection against harmful interference in a residential installation. This equipment generates, uses and can radiate radio frequency energy and, if not installed and used in accordance with the instructions, may cause harmful interference to radio communications.

However, there is no guarantee that interference will not occur in a particular installation. If this equipment does cause harmful interference to radio or television reception, which can be determined by turning the equipment off and on, the user is encouraged to try to correct the interference by one or more of the following measures:

- Reorient or relocate the WRS101.
- Increase the separation between the WRS101 and the effected equipment.
- Connect the WRS101 into an electrical outlet on a circuit different from that of the effected equipment.
- Consult an experienced radio/TV technician for help.

Product Name : NOAA SAME WEATHER RADIO
Model Name : WRS101
Responsible Party : Oregon Scientific Inc.
19861 SW 95th Place
Tualatin, Oregon 97062 U.S.A.
Tel: 503-639-8883



086-002226-02

osi-usa
WRS101